



Cisco Aironet Four-Element, MIMO, Dual-Band Ceiling Mount Omni-Directional Antenna (AIR-ANT2524V4C-R= and AIR-ANT2524V4C-RS=)

Last Updated: February 06, 2020

This document describes the AIR-ANT2524V4C-Rx= antennas, and provides specifications and mounting instructions. Both antennas are four-element, MIMO, dual-band antennas that operate in the 2.4 GHz and 5 GHz frequency ranges. Both antennas are designed for ceiling mounting in an indoor environment. The AIR-ANT2524V4C-RS= antenna includes self-identifying circuitry.

These topics are discussed:

- [Technical Specifications, page 2](#)
- [System Requirements, page 5](#)
- [Safety Instructions, page 5](#)
- [Installation Notes, page 5](#)
- [Choosing a Mounting Location, page 6](#)
- [Installing the Antenna, page 6](#)
- [Obtaining Documentation and Submitting a Service Request, page 9](#)

Technical Specifications

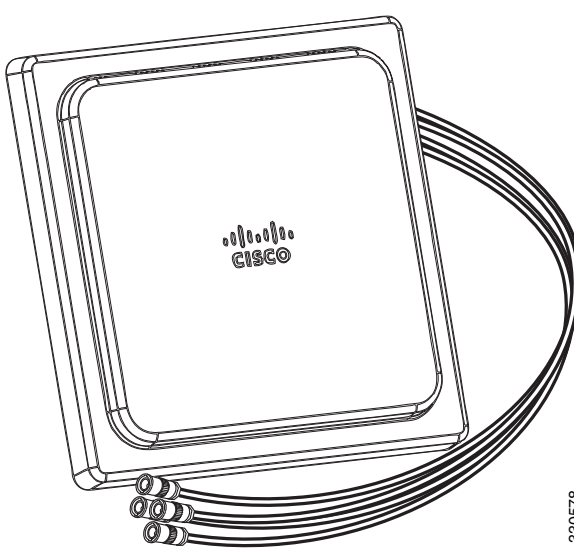
Antenna type	4-Element, Dual-band, Low Profile Omni	
Operating frequency ranges	2400-2484 MHz 5150-5850 MHz	
VSWR	2:1 or less in both bands	
Peak gain	2.4-GHz band: 2 dBi 5-GHz band: 4 dBi	
Polarization	Linear	
Azimuth plane 3 dB beamwidth	Omni-directional	
Elevation plane 3 dB beamwidth	2.4 GHz band: 69° 5 GHz band: 60°	
Length	7.25 in (18.4 cm)	
Width	7.25 in (18.4 cm)	
Depth	1 in (2.5 cm)	
Weight	1.3 lb (0.59 kg)	
Cable	3 ft (91.4 cm) plenum rated, UV stable	
Connector	RP-TNC	
Environment	Indoor	
Temperature range	32-133° F (0-56° C)	

Technical Specifications

2.4 GHz Element 1 Azimuth and Elevation Plane Patterns

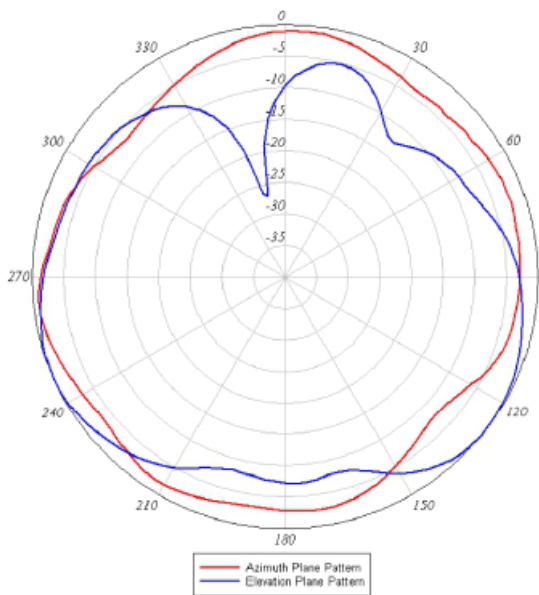

5 GHz Element 1 Azimuth and Elevation Plane Patterns

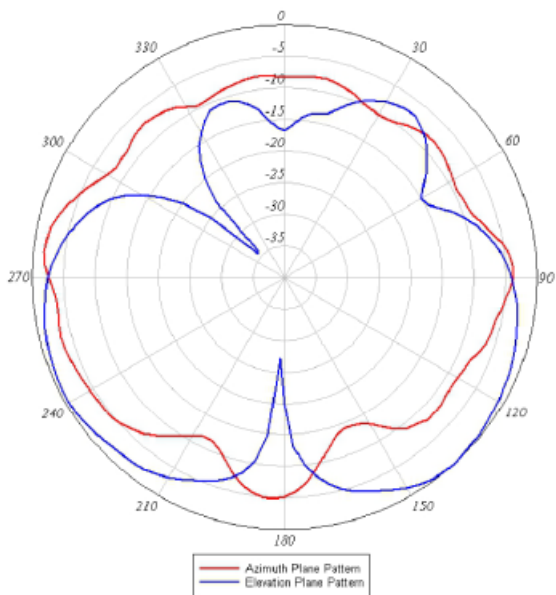

330576

330575

2.4 GHz Element 2 Azimuth and Elevation Plane Patterns

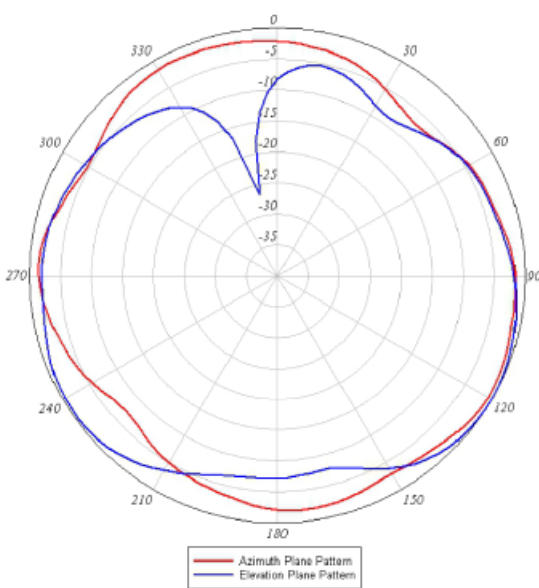

330574

5 GHz Element 2 Azimuth and Elevation Plane Patterns

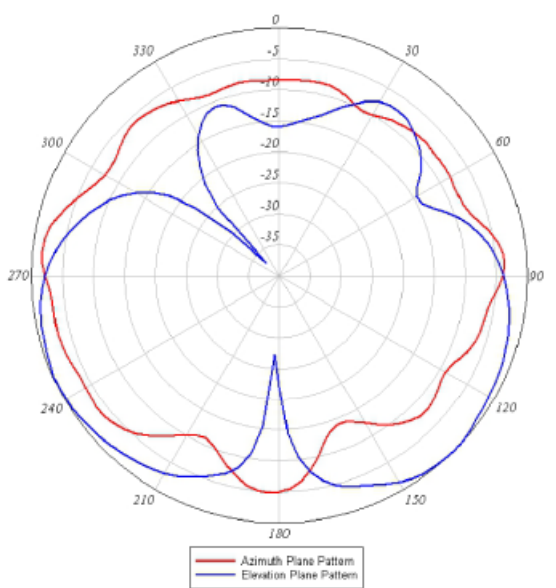

330573

Technical Specifications

2.4 GHz Element 3 Azimuth and Elevation Plane Patterns

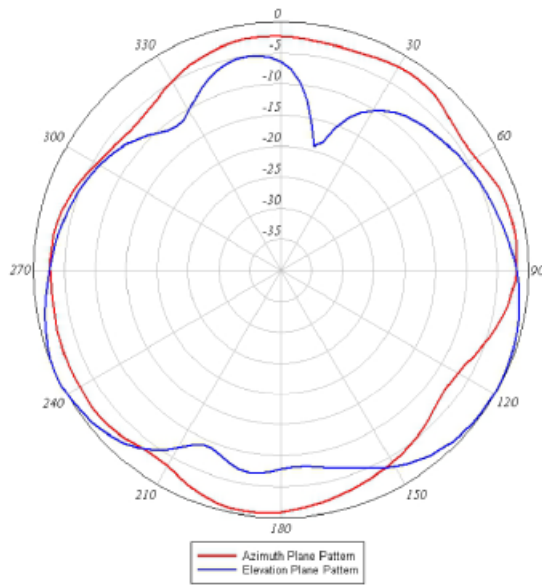

5 GHz Element 3 Azimuth and Elevation Plane Patterns

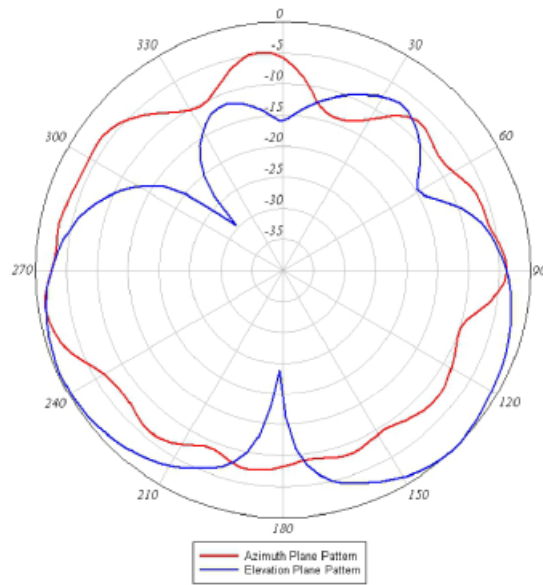

330572

330575

2.4 GHz Element 4 Azimuth and Elevation Plane Patterns

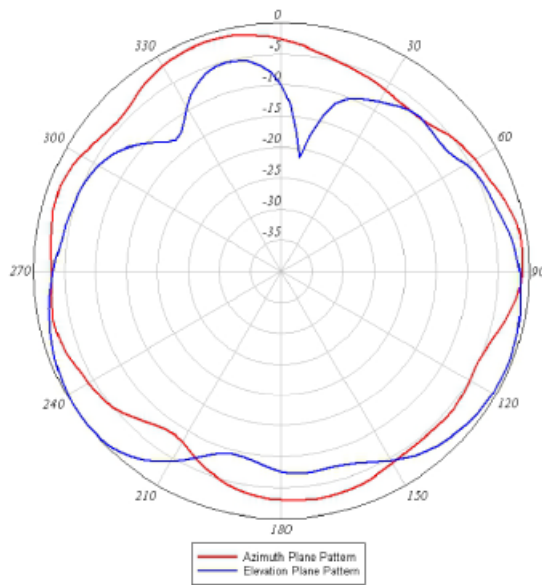

330570

5 GHz Element 4 Azimuth and Elevation Plane Patterns

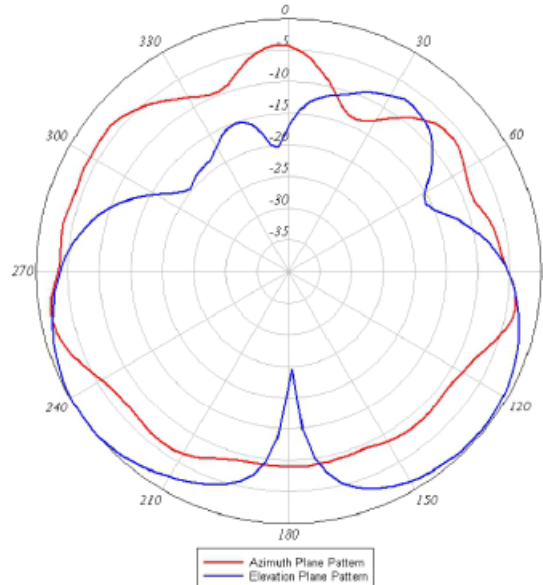

330577

System Requirements

This antenna is for indoor use with any Cisco Aironet radio device with dual-band (2.4 and 5 GHz) RP-TNC antenna ports. The antenna can be mounted on suspended ceiling tiles having a thickness between ½ in. (1.27 cm) and 1 in. (2.54 cm).

Safety Instructions

Follow these safety instructions when installing your antenna.

- Plan your installation procedure carefully and completely before you begin.
- If you are installing an antenna for the first time, for your own safety as well as others, seek professional assistance. Consult your dealer, who can explain which mounting method to use for the location where you intend to install the antenna.
- Select your installation site with safety, as well as performance, in mind. Remember that electric power cables and telephone lines look alike. For your safety, assume that any line is an electric power line until determined otherwise.
- Call your local power company or building maintenance organization if you are unsure about cables close to your mounting location.
- When installing your antenna:
 - **Do not** use a metal ladder.
 - Dress properly: shoes with rubber soles and heels, rubber gloves, and a long sleeved shirt or jacket.
- If an accident or emergency occurs with the power lines, call for qualified emergency help immediately.

Installation Notes

Because antennas transmit and receive radio signals, they are susceptible to RF obstructions and common sources of interference that can reduce throughput and range of the device to which they are connected. Follow these guidelines to ensure the best possible performance:

- Mount the antenna to utilize its propagation characteristics. A way to do this is to orient the antenna horizontally as high as possible at or near the center of its coverage area.
- Keep the antenna away from metal obstructions such as heating and air-conditioning ducts, large ceiling trusses, building superstructures, and major power cabling runs. If necessary, use a rigid conduit to lower the antenna away from these obstructions.
- The density of the materials used in a building's construction determines the number of walls the signal must pass through and still maintain adequate coverage. Consider the following before choosing the location to install your antenna:
 - Paper and vinyl walls have very little affect on signal penetration.
 - Solid and pre-cast concrete walls limit signal penetration to one or two walls without degrading coverage.
 - Concrete and wood block walls limit signal penetration to three or four walls.
 - A signal can penetrate five or six walls constructed of drywall or wood.
 - A thick metal wall causes signals to reflect off, causing poor penetration.

Choosing a Mounting Location

- A wire mesh spaced between 1 and 1 1/2 in. (2.54 and 3.81 cm) acts as a harmonic reflector that blocks a 2.4 GHz radio signal.
- Install the antenna away from microwave ovens and 2-GHz cordless phones. These products can cause signal interference because they operate in the same frequency range as the device to which your antenna is connected.
- Install the antenna horizontally to maximize signal propagation.

Choosing a Mounting Location

Mount the antenna mounted clear of obstructions to the sides of the radiating elements. Generally, the higher an antenna is above the floor, the better it performs. If possible, mount the antenna on the ceiling panel within 12 in. (30.5 cm) of the access point so you can connect its cables directly to the access point. If you must mount the antenna farther away from the access point, try to make the distance as short as possible.

Installing the Antenna

You can install the antenna on a ceiling tile having a thickness between 1/2 in. (1.27 cm) and 1 in. (2.54 cm).

Tools and Equipment Required

The following tools and equipment are not provided:

- 1" (2.54 cm) hole saw to create a hole in the suspended ceiling tile.
- A step ladder high enough to access your ceiling safely.

Installing the Antenna

The antenna is installed to a suspended ceiling tile with a supplied 1 in. (2.54 cm) plastic nut. See [Figure 1 on page 7](#) for details.

The antenna cables terminate with a straight RP-TNC plug connector after a 36 in. (91.44 cm) cable. The mating connector to the antenna on the access point is an RP-TNC jack.

Mounting the Antenna on a Ceiling Tile

Figure 1 Ceiling Tile Mounting Details

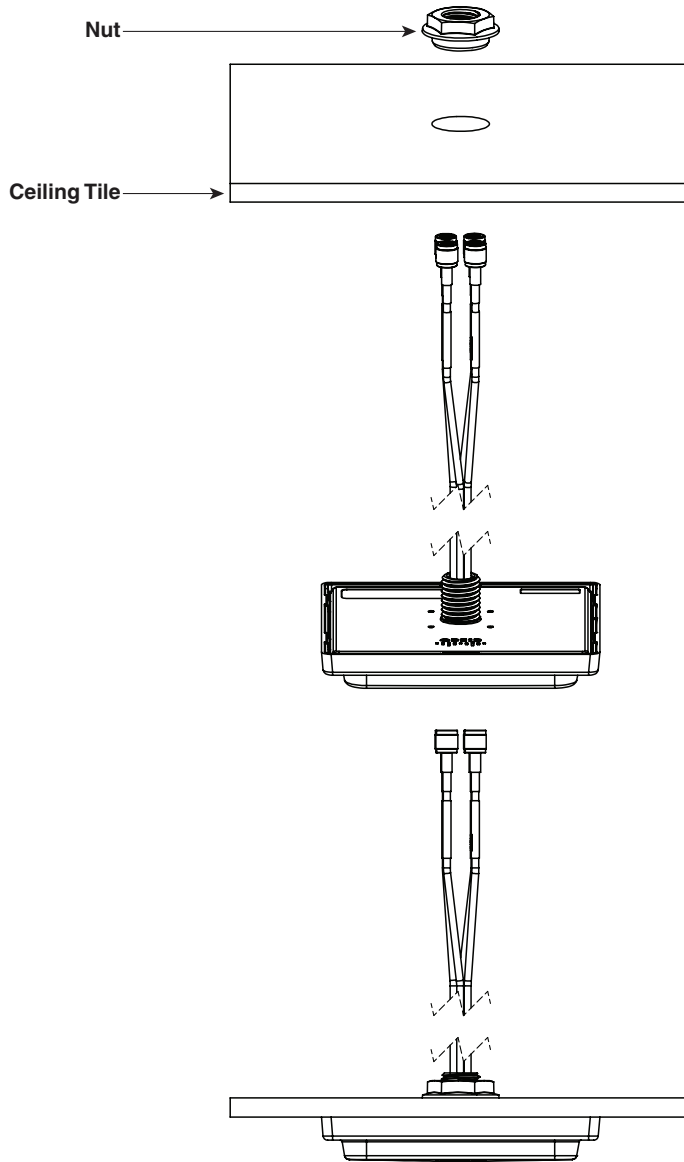

To mount the antenna on a suspended ceiling tile:

1. Mark the mounting location on the ceiling tile.
2. Remove the ceiling tile from the ceiling grids.
3. Use a 1" (2.54 cm) hole saw to cut a hole in the ceiling tile.
4. Insert the antenna cables, one at a time, through the hole in the ceiling tile.
5. Insert the antenna cables, one at a time, through the hole in the plastic nut as shown in [Figure 1 on page 7](#).

Note: Do not use the rubber gasket when you mount the antenna on a ceiling tile. The gasket is not required for ceiling tile installations.

6. Ensure that the antenna is properly positioned on the ceiling tile and then tighten the plastic nut hand-tight.
7. Reinstall the ceiling tile.
8. Connect the antenna cables to the access point.

Note: The 5 GHz antenna cables are identified by an orange collar near the connectors. Ensure that you connect these cables to the 5 GHz antenna connection on the access point.

Connecting the Antenna to the Access Point

The AIR-ANT2524V4C-R= has four cables with orange labels. The four cables can be connected to any of the four ports on the access point.

The AIR-ANT2524V4C-RS= includes circuitry to enable self-identification of the antenna by the Cisco Catalyst 91xx Series access points. The antenna has three cables with orange labels and one cable with a purple label. The self-identifying function is indicated by the purple label on this cable. Ensure that this antenna cable is connected to Port A on the AP, which is also designated by purple text around the RP-TNC connector. The AIR-ANT2524V4C-RS= antenna has a built-in EEPROM that can be read by the AP to automatically configure the antenna type and gain in the wireless controller.

Suggested Cable

We recommend using a high-quality, low-loss cable with the antenna.

Note: Coaxial cable loses efficiency as the frequency increases, resulting in signal loss. Keep the cable as short as possible as cable length determines the amount of signal loss (the longer the run, the greater the loss).

Communications, Services, and Additional Information

- To receive timely, relevant information from Cisco, sign up at [Cisco Profile Manager](#).
- To get the business impact you're looking for with the technologies that matter, visit [Cisco Services](#).
- To submit a service request, visit [Cisco Support](#).
- To discover and browse secure, validated enterprise-class apps, products, solutions and services, visit [Cisco Marketplace](#).
- To obtain general networking, training, and certification titles, visit [Cisco Press](#).
- To find warranty information for a specific product or product family, access [Cisco Warranty Finder](#).

Cisco Bug Search Tool

[Cisco Bug Search Tool](#) (BST) is a web-based tool that acts as a gateway to the Cisco bug tracking system that maintains a comprehensive list of defects and vulnerabilities in Cisco products and software. BST provides you with detailed defect information about your products and software.

THE SPECIFICATIONS AND INFORMATION REGARDING THE PRODUCTS IN THIS MANUAL ARE SUBJECT TO CHANGE WITHOUT NOTICE. ALL STATEMENTS, INFORMATION, AND RECOMMENDATIONS IN THIS MANUAL ARE BELIEVED TO BE ACCURATE BUT ARE PRESENTED WITHOUT WARRANTY OF ANY KIND, EXPRESS OR IMPLIED. USERS MUST TAKE FULL RESPONSIBILITY FOR THEIR APPLICATION OF ANY PRODUCTS.

THE SOFTWARE LICENSE AND LIMITED WARRANTY FOR THE ACCOMPANYING PRODUCT ARE INCORPORATED HEREIN BY THIS REFERENCE. IF YOU ARE UNABLE TO LOCATE THE SOFTWARE LICENSE OR LIMITED WARRANTY, CONTACT YOUR CISCO REPRESENTATIVE FOR A COPY.

The following information is for FCC compliance of Class A devices: This equipment has been tested and found to comply with the limits for a Class A digital device, pursuant to part 15 of the FCC rules. These limits are designed to provide reasonable protection against harmful interference when the equipment is operated in a commercial environment. This equipment generates, uses, and can radiate radio-frequency energy and, if not installed and used in accordance with the instruction manual, may cause harmful interference to radio communications. Operation of this equipment in a residential area is likely to cause harmful interference, in which case users will be required to correct the interference at their own expense.

The following information is for FCC compliance of Class B devices: This equipment has been tested and found to comply with the limits for a Class B digital device, pursuant to part 15 of the FCC rules. These limits are designed to provide reasonable protection against harmful interference in a residential installation. This equipment generates, uses and can radiate radio frequency energy and, if not installed and used in accordance with the instructions, may cause harmful interference to radio communications. However, there is no guarantee that interference will not occur in a particular installation. If the equipment causes interference to radio or television reception, which can be determined by turning the equipment off and on, users are encouraged to try to correct the interference by using one or more of the following measures:

- Reorient or relocate the receiving antenna.
- Increase the separation between the equipment and receiver.
- Connect the equipment into an outlet on a circuit different from that to which the receiver is connected.
- Consult the dealer or an experienced radio/TV technician for help.

Modifications to this product not authorized by Cisco could void the FCC approval and negate your authority to operate the product.

The Cisco implementation of TCP header compression is an adaptation of a program developed by the University of California, Berkeley (UCB) as part of UCB's public domain version of the UNIX operating system. All rights reserved. Copyright © 1981, Regents of the University of California.

NOTWITHSTANDING ANY OTHER WARRANTY HEREIN, ALL DOCUMENT FILES AND SOFTWARE OF THESE SUPPLIERS ARE PROVIDED "AS IS" WITH ALL FAULTS. CISCO AND THE ABOVE-NAMED SUPPLIERS DISCLAIM ALL WARRANTIES, EXPRESSED OR IMPLIED, INCLUDING, WITHOUT LIMITATION, THOSE OF MERCHANTABILITY, FITNESS FOR A PARTICULAR PURPOSE AND NONINFRINGEMENT OR ARISING FROM A COURSE OF DEALING, USAGE, OR TRADE PRACTICE.

IN NO EVENT SHALL CISCO OR ITS SUPPLIERS BE LIABLE FOR ANY INDIRECT, SPECIAL, CONSEQUENTIAL, OR INCIDENTAL DAMAGES, INCLUDING, WITHOUT LIMITATION, LOST PROFITS OR LOSS OR DAMAGE TO DATA ARISING OUT OF THE USE OR INABILITY TO USE THIS MANUAL, EVEN IF CISCO OR ITS SUPPLIERS HAVE BEEN ADVISED OF THE POSSIBILITY OF SUCH DAMAGES.

Any Internet Protocol (IP) addresses and phone numbers used in this document are not intended to be actual addresses and phone numbers. Any examples, command display output, network topology diagrams, and other figures included in the document are shown for illustrative purposes only. Any use of actual IP addresses or phone numbers in illustrative content is unintentional and coincidental.

All printed copies and duplicate soft copies of this document are considered uncontrolled. See the current online version for the latest version.

Cisco has more than 200 offices worldwide. Addresses, phone numbers, and fax numbers are listed on the Cisco website at www.cisco.com/go/offices.

© 2020 Cisco Systems, Inc. All rights reserved.

